



**INSTRUCTIONS D'ASSEMBLAGE**  
**ASSEMBLY INSTRUCTIONS**

---

**M**ONARCH  
SPECIALTIES INC.

# I 1070

---

**TABLE A MANGER -**  
**40"DIA / METAL CHROME / VERRE TREMPE 8MM**

**DINING TABLE -**  
**40"DIA CHROME WITH 8MM TEMPERED GLASS**





**POUR DE L'ASSISTANCE OU POUR COMMANDER  
DES PIÈCES CONTACTEZ NOTRE DÉPARTEMENT  
DE SERVICE À LA CLIENTÈLE.**

**FOR ASSISTANCE OR TO ORDER PARTS  
CONTACT OUR CUSTOMER SERVICE DEPARTMENT**

**WWW.MONARCHSERVICE.COM**

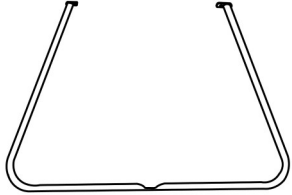
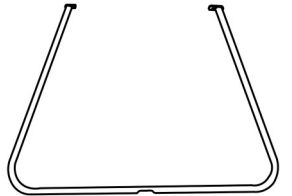
**LISTE DES PIÈCES**  
**PARTS LIST**

PIÈCE / PART #	IMAGE	DESCRIPTION	QTY / QTÉ
1		TABLE LEG PATTE DE TABLE	1
2		TABLE LEG PATTE DE TABLE	1
3		GLASS TOP SURFACE EN VERRE	1

**LISTE DES PIÈCES DE MONTAGE**  
**HARDWARE LIST**

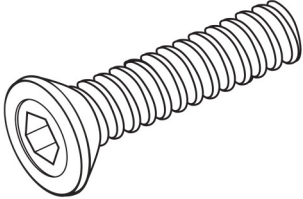
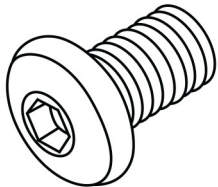
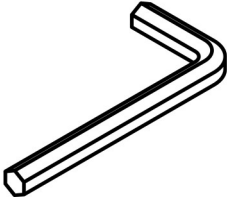
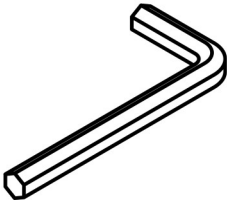
PIÈCE / PART #	IMAGE	DESCRIPTION	QTY / QTÉ
A		<p align="center">ASSEMBLING BOLT - Ø1/4" X 3/4" BOULON D'ASSEMBLAGE - Ø1/4" X 3/4"</p>	1
B		<p align="center">ASSEMBLING BOLT - Ø3/8" X 3/8" BOULON D'ASSEMBLAGE - Ø3/8" X 3/8"</p>	4
C		<p align="center">HEX KEY - M5 , 4M CLÉ HEXAGONALE - M5 , 4M</p>	1
D		<p align="center">HEX KEY - M4 , 3M CLÉ HEXAGONALE - M4 , 3M</p>	1

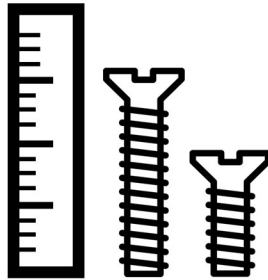

OUTIL DE VÉRIFICATION DE DIMENSIONS DES PIÈCES  
HARDWARE DIMENSIONS VERIFICATION TOOL

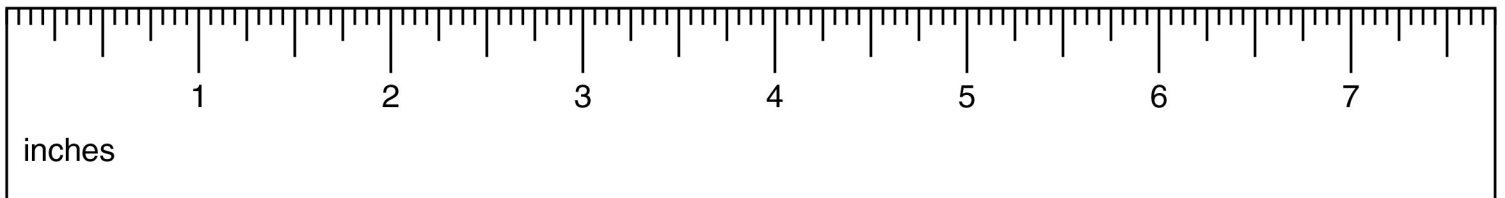

ÉTAPE / STEP 1

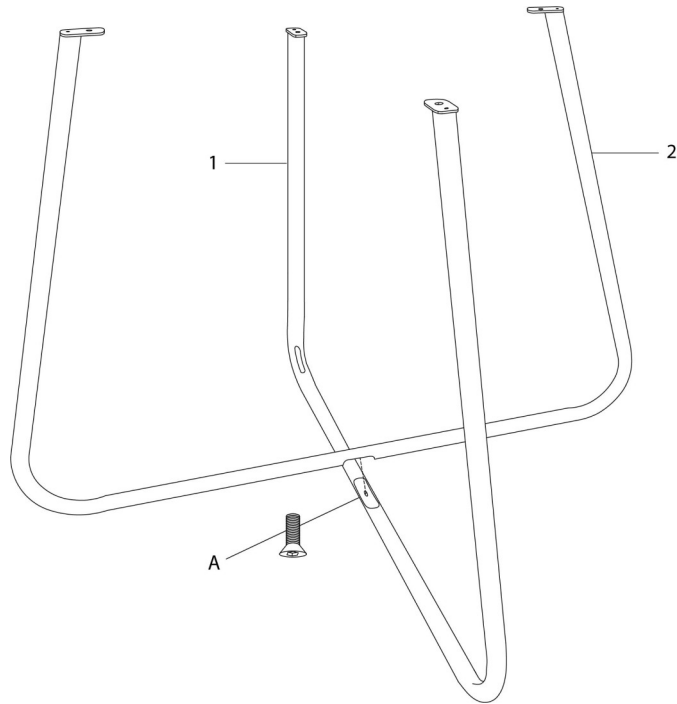

ÉTAPE / STEP 2

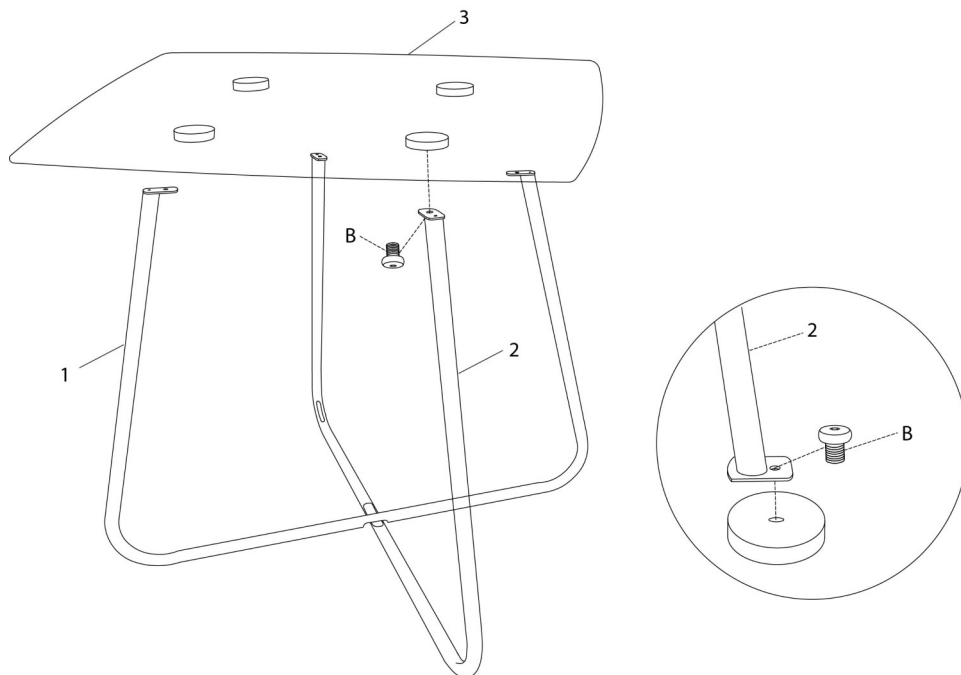

ÉTAPE / STEP 3

